



Bollards
Columns
Lanterns
Accessories

Lighting

COLUMNS

Lighting forms an essential part of many enhancement schemes. Lighting generally takes two forms. One is the functional column and luminaires, where design may not be of importance, but specification and price are. The alternative would be decorative lighting. This is designed to be visually stimulating but to give similar levels of performance. Almost all of the designs shown in this brochure are suitable for roadside illumination.

Lighting columns 601 and 602 are manufactured from galvanised steel and are 5m high as standard.



613 + 630

Lighting

Lighting

Lighting columns from 603 onwards are constructed from a galvanised steel root, base and column assembly with a fully sealed and finished cast iron decorative base. The column height can be specified, usually between 3m and 6m.



601



602

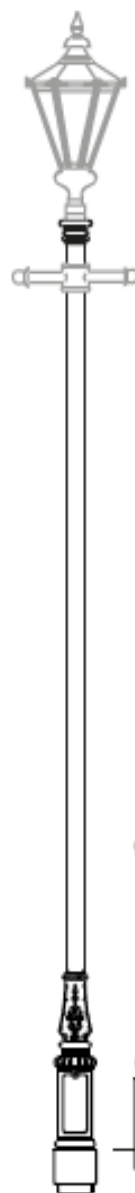
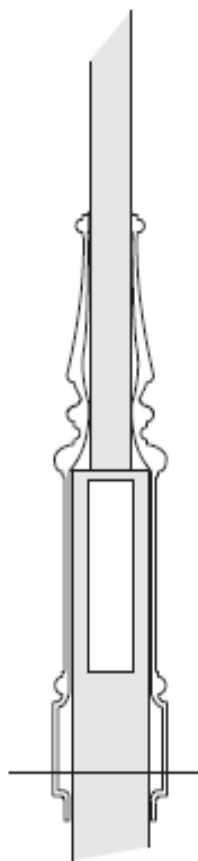

603

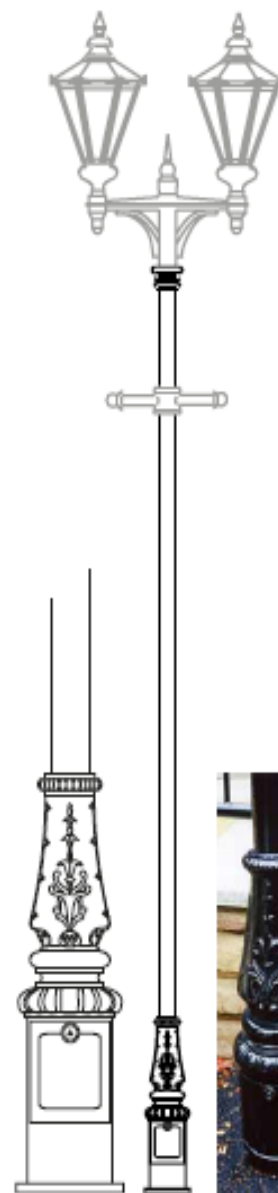

604



COLUMNS



603 + 630



603 + 630

COLUMNS



6.4

Lighting

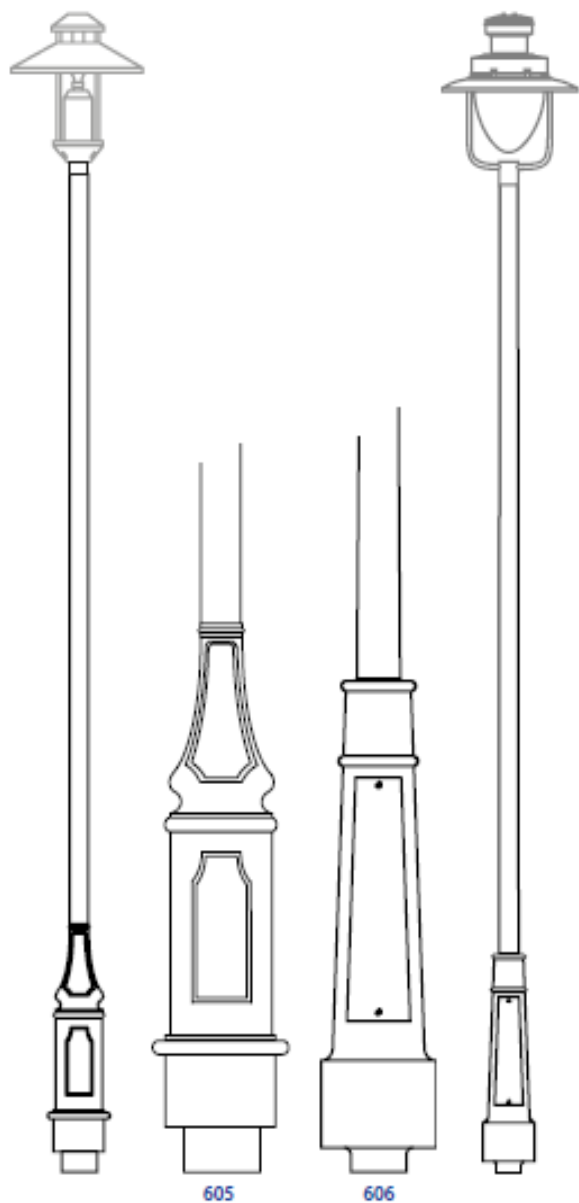

Lighting

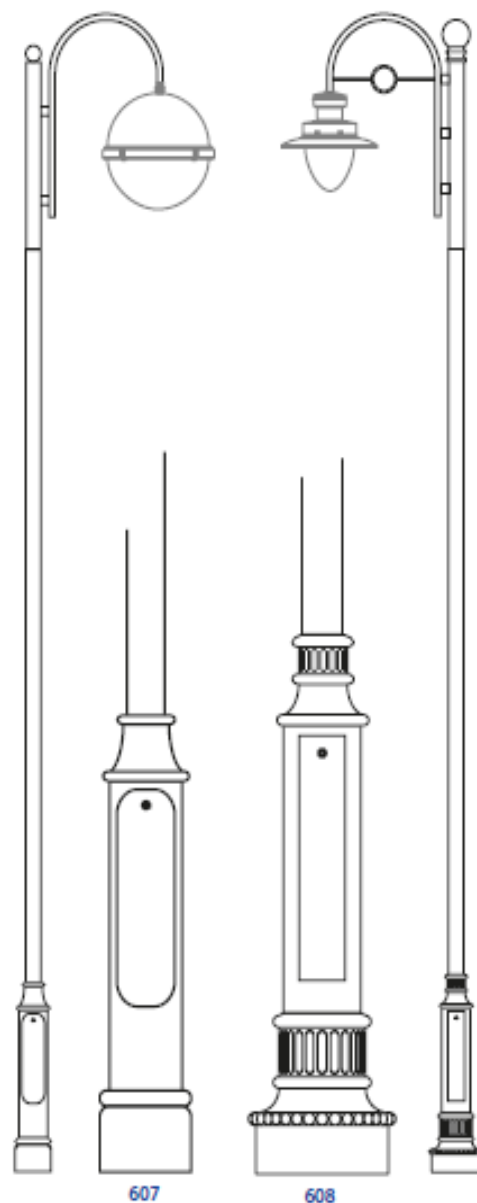

COLUMNS

All column designs have been carefully chosen to match and blend with other forms of furniture, giving a seamless look, even in the most demanding of developments.



6.5

COLUMNS



613 + 633

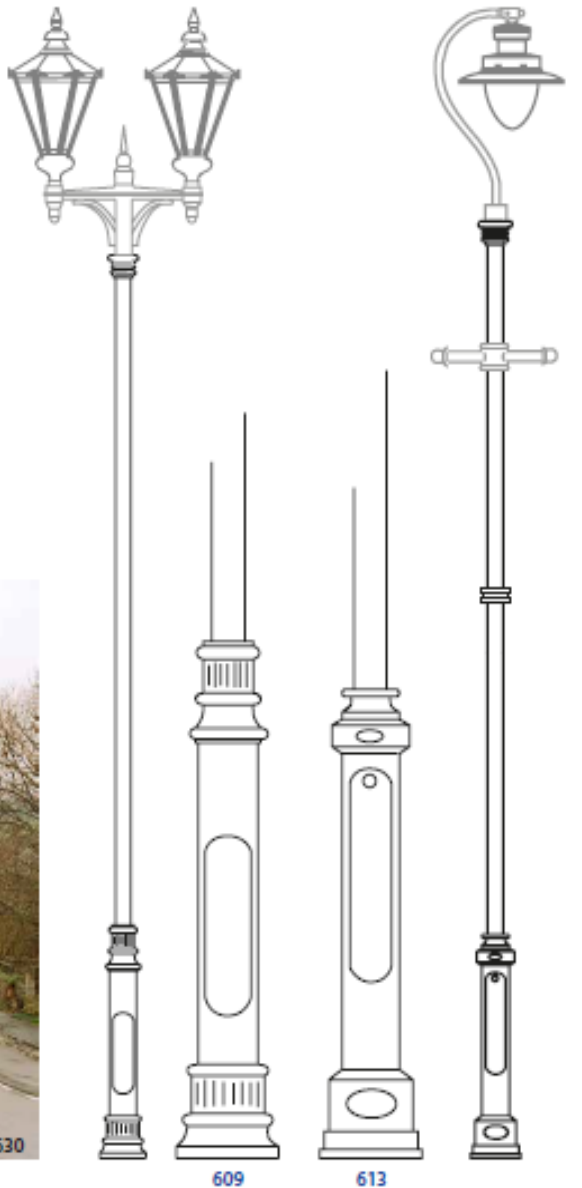

609

613

Lighting

Lighting

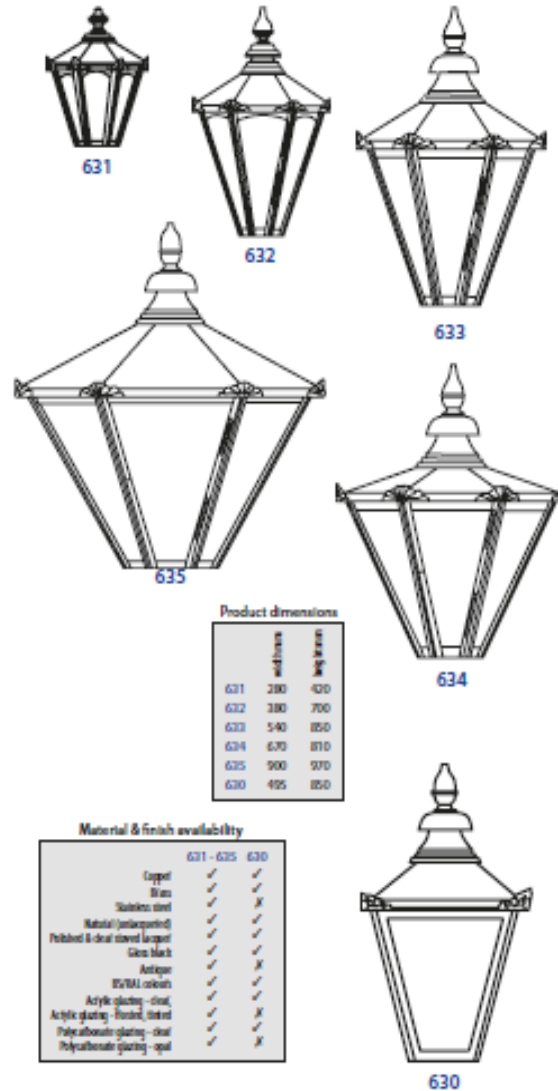

631

632

633

635

634

Product dimensions

	width	height
631	280	420
632	380	700
633	540	850
634	670	870
635	900	970
630	495	850

Material & finish availability

	631 - 635	630
Copper	✓	✓
Steel	✓	✓
Stainless steel	✓	X
Natural (unlacquered)	✓	✓
Polished & clear coated lacquer	✓	✓
Clear black	✓	✓
Antique	✓	X
ESVAI colors	✓	✓
Acrylic glazing - clear	✓	✓
Acrylic glazing - tinted, tinted	✓	X
Polycarbonate glazing - clear	✓	✓
Polycarbonate glazing - opal	✓	X

630

LANTERNS



633



630

LANTERNS



637 + 674



639

Material & finish availability

Cast aluminum body, open aluminum canopy	standard
Servit	optional
Chlorac plus polyester powder coat	standard
Galvanized	optional
Raw	optional
ES/MS colors	optional
No optic	standard
Reflector optic	optional
Diffuser optic	optional
Louver slat	optional
GLS lamp & control gear, 100W	standard
Polycarbonate glazing, clear	standard

Lighting

Lighting

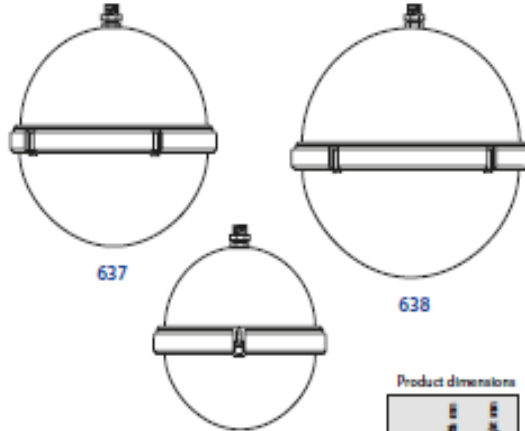

637

638

636

Product dimensions

	Ø	H	W
636	500	500	
637	600	600	
638	700	700	
639	525	540	
640	525	540	
641	525	415	
642	525	415	

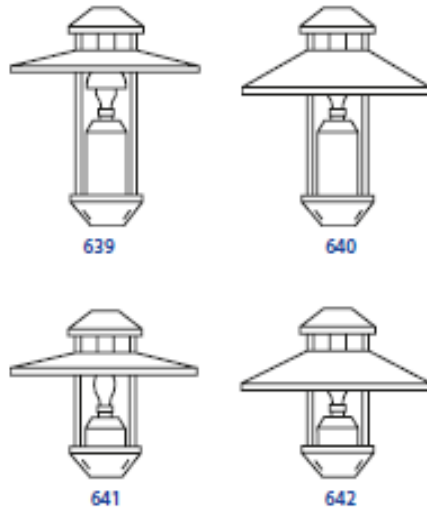

639

640

641

642

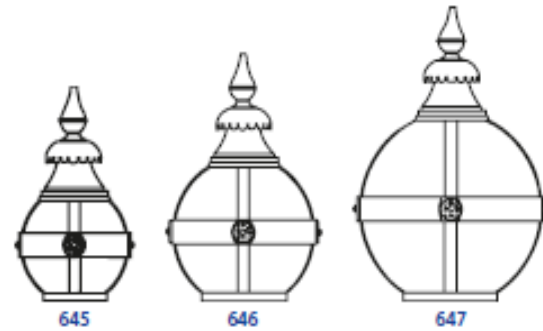

645

646

647

Material & finish availability

Aluminum	615/647
Chlorac	Polycast powder coat black
	ES/MS colors
Copper	Polished & lacquered
	Antique bronze
Blas	Polished & lacquered
	Clear acrylic
	Opal acrylic
Double 316 stainless polycarbonate	Clear, Opal, Frosted

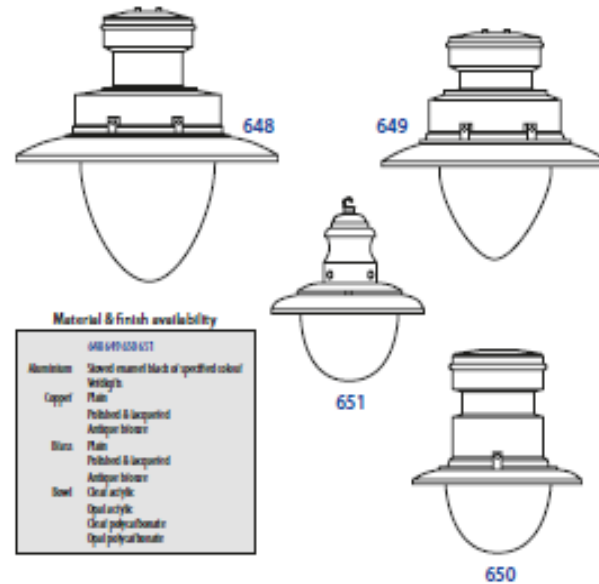

648

649

651

650

Material & finish availability

Aluminum	648 649 650 651
	Stained enamel black or specified color
Welding's	
Copper	Plain
	Polished & lacquered
	Antique bronze
Blas	Plain
	Polished & lacquered
	Antique bronze
Sand	Clear acrylic
	Opal acrylic
	Clear polycarbonate
	Opal polycarbonate

LANTERNS



646 + half banded version

Product dimensions

	Ø	H	W
645	300	300	
646	400	300	
647	500	300	
648	675	670	200
649	585	615	200
650	430	490	150
651	295	295	150

All lanterns on this page have an E27 lamp holder for GLS/ self-contained fluorescent lamps



649

ACCESSORIES

Outreach brackets are available to suit the full range of columns shown. Our sales staff can advise on the fitting of certain types of lanterns to the correct brackets.

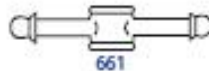
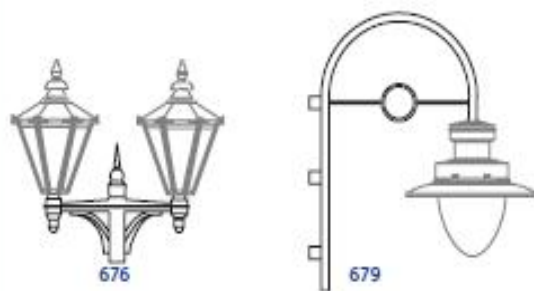
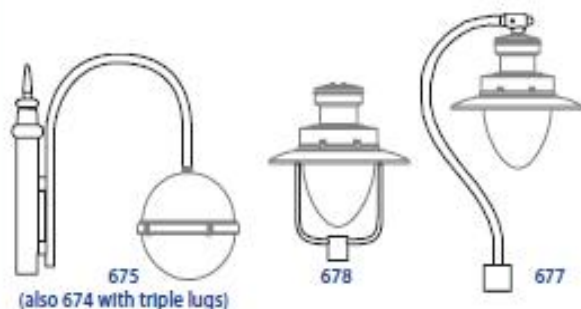

Ladder bars are suitable for fitting to all columns. Cast ladder bars are illustrated in varying sizes. Ladder bars may also be adapted to accommodate hanging baskets or banners.

Lighting

Lighting



ILLUMINATED BOLLARDS

An attractive and robust collection of lighting bollards to suit any landscaping scheme. All have the option of being adapted to take chains or railings.

Product data

	height in mm	height in ft	width in mm	width in ft	material	finish
681	168	1100	260	galv steel	E27	
682B	200	1200	260	galv steel	E27	
682F	200	1200	-	galv steel	E27	
684	165	1025	-	cast iron	E27	
685	180	990	-	cast iron	E27	
1061	220	1000	300	cast iron	PL	
1401	140	900	300	cast iron	PL	
1531	140	900	300	composite	CF	

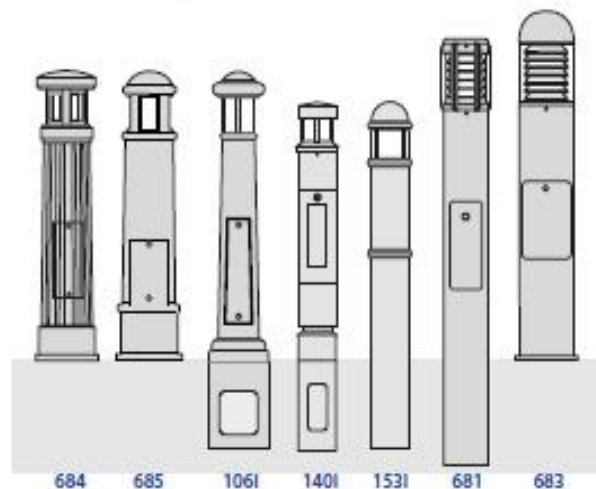

CONTACT US

V.G.SALES,
CB – 195 , RING ROAD,
NARAINA,
New Delhi – 110028
Ph. 011-25778093

Mail: info@vgsales.in

Web : www.vgsales.in , www.moldosports.com

For V.G.Sales,
Mr. Shakti Singh
(Manager)

(M): 9958250808

Mail : shakti.altro@gmail.com